

Secure linkage in vice and tighten bolts. Do not Torque. Allow steel bracket to rotate freely.

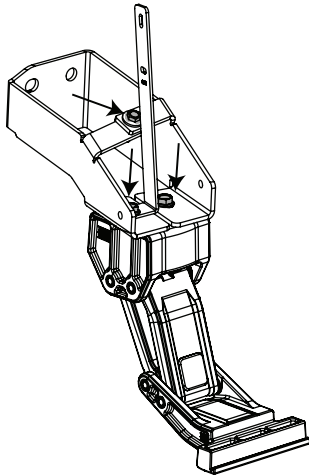

1

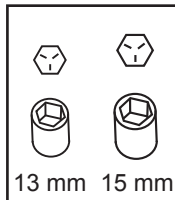

2

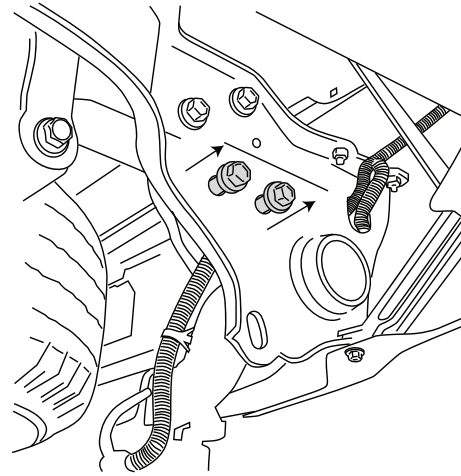

Remove Fender Brace with 10mm socket or wrench.

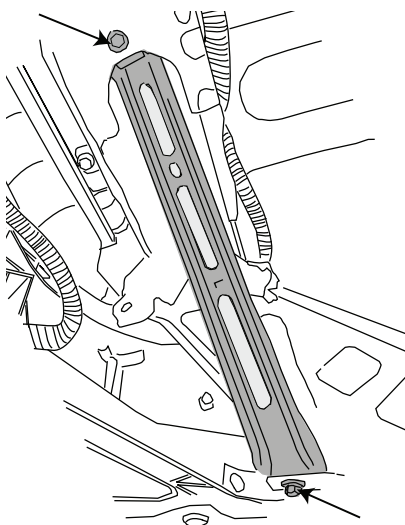

3



4

Install mounting bracket using factory fasteners. Torque fasteners to 90ft-lbs/125Nm.

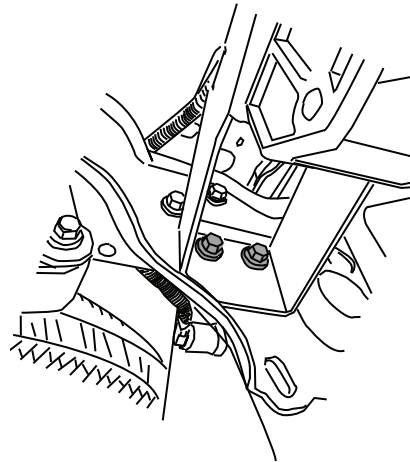

TECH SUPPORT 1-888-983-2204 Monday - Friday, 7:00 AM - 5:00 PM PST

Designed and manufactured by AMP Research. Patent 6,830,257 / 6,641,158 / 6,834,875 / 6,938,909 / 6,942,233 / 7,007,961 / 7,055,839 / 7,163,221
Other US and worldwide patents pending. Three-year limited warranty. "BEDSTEP" is a trademark of AMP Research.

Remove harness retainer clip from hole and use one bolt from step 3. Use supplied M6 nut and tighten to 12ft-lbs.

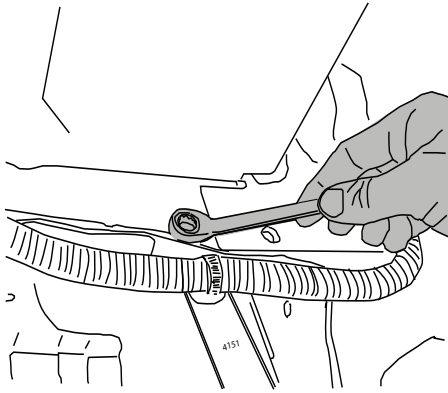

5

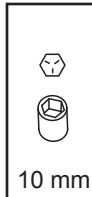

Reattach harness to bracket.

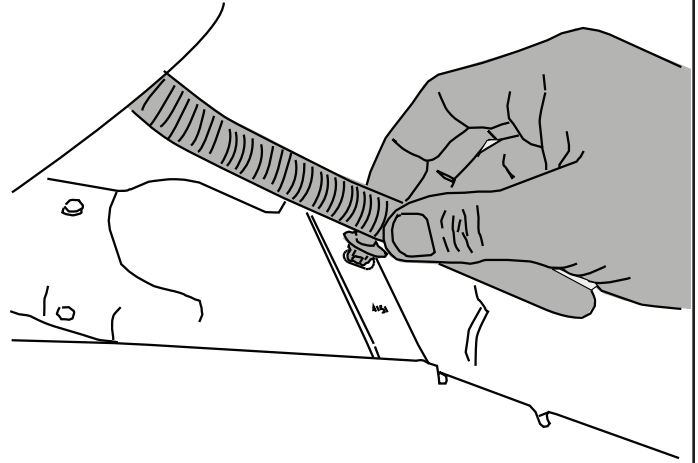

6

Attach rear support bracket to bed panel and main bracket as shown. Torque bolts to 16ft-lb.

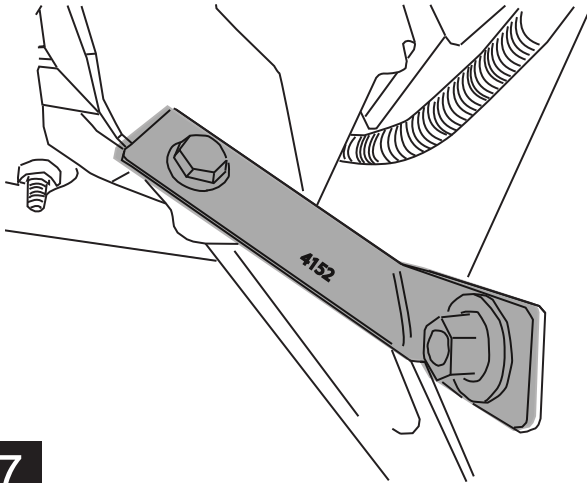

7

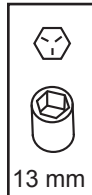

Attach fender support bracket to main bracket as shown. Use supplied M6 nut and bolt from step 3 and tighten to 12ft-lbs.

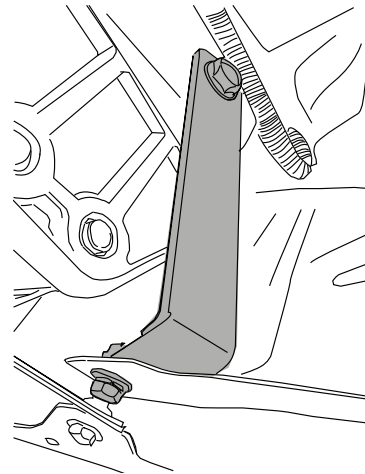

8

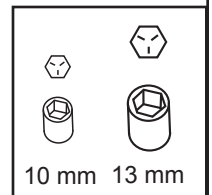

Torque bolts to 6 ft-lbs / 8 Nm.

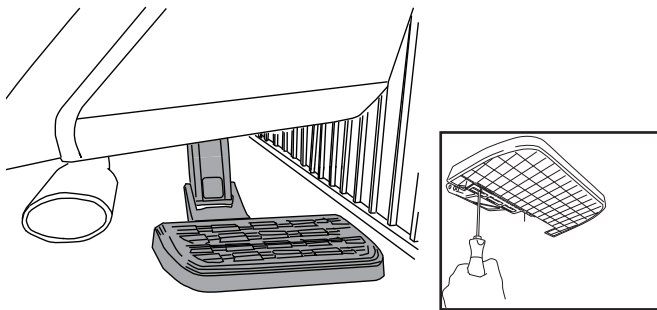

NOTE: Overtightening may damage step pad

9

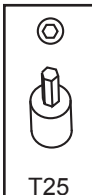

Align step pad with bumper and tighten bolts from step 1.

A: Torque 10mm bolts to 33ftlbs/44Nm.

B: Torque 8mm bolt to 16ft-lb.

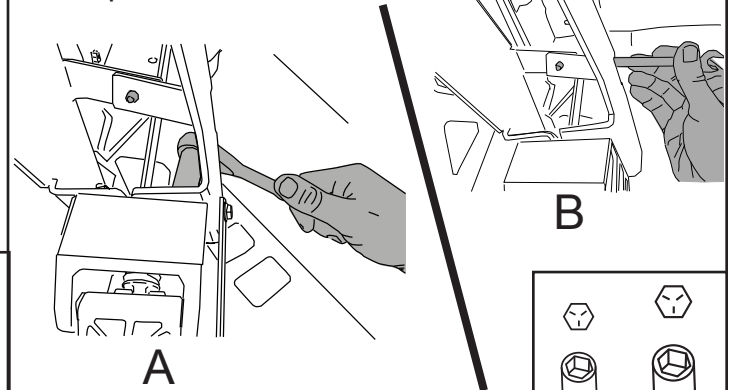

10

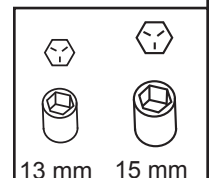

Congratulations on the purchase of your AMP RESEARCH BedStep®



Here's what you should know...

OPERATION

- The AMP Research BedStep® is foot operated and deploys and retracts with a nudge of your foot.
- To deploy, press down using your left foot, on the forward outside corner of the step pad.
- To retract, gently kick the underside of the step pad.
- Max Load Capacity: 300lbs.

- Always use appropriate hand holds when stepping up to or down from your truck's cargo bed.

MAINTENANCE TIPS

The step pad surface and linkage arms can be washed with mild soap and water using a soft brush or sponge to dislodge any mud, dirt or accumulated road grime. Rinse with fresh water.

To prevent slipping, avoid applying waxes, lubricants or protectants like Armor All® to the step surface.

ATTENTION!

BEDSTEP SHOULD ALWAYS BE STOWED IN THE RETRACTED POSITION WHEN DRIVING.

amp-research.com

LIMITED WARRANTY

AMP RESEARCH warrants product to be free from defects in material and workmanship, for terms specified below, provided there has been normal use and proper maintenance. All remedies under this warranty are limited to the repair or replacement of any item found by the factory to be defective within the time period specified.

If you have a warranty claim, first you must call our factory at the number below for instructions. You must retain proof of purchase and submit a copy with any items returned for warranty work. Upon completion of warranty work, if any, we will return the repaired or replaced item or items to you freight prepaid. Damage to our products caused by accidents, fire, vandalism, negligence, misinstallation, misuse, Acts of God, or by defective parts not manufactured by us, is not covered under this warranty.

THE WARRANTY TIME PERIOD IS AS FOLLOWS: THREE YEARS FROM DATE OF PURCHASE.

ANY IMPLIED WARRANTIES OF MERCHANTABILITY AND/OR FITNESS FOR A PARTICULAR PURPOSE CREATED HEREBY ARE LIMITED IN DURATION TO THE SAME DURATION AND SCOPE AS THE EXPRESS WRITTEN WARRANTY. OUR COMPANY SHALL NOT BE LIABLE FOR ANY INCIDENTAL OR CONSEQUENTIAL DAMAGE.

Some states do not allow limitations on how long an implied warranty lasts, or the exclusion or limitation of incidental or consequential damages, so the above limitations or exclusions may not apply to you. This warranty gives you specific legal rights, and you may also have other rights that vary from state to state.

FOR WARRANTY ISSUES WITH THIS PRODUCT PLEASE CALL AMP RESEARCH CUSTOMER SERVICE 1-888-983-2204

WARNING

Be sure to read and precisely follow the provided instructions when installing this product. Failure to do so could place the vehicle occupants in a potentially dangerous situation. After installing or reinstalling, re-check to insure that the product is properly installed.